

MAX44000 Evaluation System

Evaluates: MAX44000

General Description

The MAX44000 evaluation system (EV system) includes one MAX44000 evaluation kit (EV kit) and one MAX44000 daughter board. The EV kit is a fully assembled and tested PCB that evaluates the MAX44000 ambient light and proximity sensor. The EV system also includes Windows XP®, Windows Vista®, and Windows® 7-compatible software that provides a simple graphical user interface (GUI) for exercising the features of the device. The EV kit comes installed with a MAX44000GDT+ in a 6-pin OTDFN package with an exposed pad.

The daughter board is an external device-under-test module that also comes with a MAX44000GDT+ installed. The daughter board can be connected to and controlled by the EV kit. The user can also evaluate the device by connecting a user-supplied controller to the daughter board.

Features

- ◆ USB Powered
- ◆ Daughter Board Powered by the EV Kit
- ◆ On-Board IR LED on EV Kit and Daughter Board
- ◆ Windows XP-, Windows Vista-, and Windows 7-Compatible Software
- ◆ Continuous Data Acquisition
- ◆ Ambient Light and Proximity Signal Plotting in the EV System Software
- ◆ RoHS Compliant
- ◆ Proven PCB Layout
- ◆ Fully Assembled and Tested

[Ordering Information](#) appears at end of data sheet.

Component Lists

MAX44000 EV System

QTY	DESCRIPTION
1	MAX44000 EV kit
1	MAX44000 daughter board

MAX44000 EV Kit

DESIGNATION	QTY	DESCRIPTION
C1–C17	17	47nF ±10%, 16V, X7R ceramic capacitors (0603) Murata GRM188R71C473K
C18–C33	16	1nF ±10%, 50V, X7R ceramic capacitors (0603) Murata GRM188R71H102K
C34, C52, C79, C80, C101	5	1µF ±10%, 16V X5R ceramic capacitors (0603) Murata GRM188R61C105K
C35, C44, C46, C50, C53–C56, C60, C61, C62, C64, C65, C66, C74, C76, C78, C100	18	0.1µF ±10%, 16V X7R ceramic capacitors (0603) TDK C1608X7R1C104K

DESIGNATION	QTY	DESCRIPTION
C36, C39	2	0.01µF ±10%, 50V, X7R ceramic capacitors (0603) Murata GRM188R71H103K
C37	1	10pF ±5%, 50V C0G ceramic capacitor (0603) Murata GRM1885C1H100J
C38	1	15pF ±5%, 50V C0G ceramic capacitor (0603) Murata GRM1885C1H150J
C40, C41	2	39pF ±5%, 50V C0G ceramic capacitors (0603) Murata GRM1885C1H390J
C47, C48	2	4.7µF ±10%, 25V X5R ceramic capacitors (1206) Murata GRM31CR71E475M

Windows, Windows XP, and Windows Vista are registered trademarks of Microsoft Corp.

MAX44000 Evaluation System

Evaluates: MAX44000

Component Lists (continued)

MAX44000 EV Kit (continued)

DESIGNATION	QTY	DESCRIPTION
C49, C63, C67, C68, C73, C75, C81	7	10 μ F \pm 10%, 25V, X5R ceramic capacitors (1206) Murata GRM31CR61E106K
C57	1	0.033 μ F \pm 10%, 16V X5R ceramic capacitor (0603) Taiyo Yuden EMK107BJ333KA
C58, C59,	2	22pF \pm 5%, 50V C0G ceramic capacitors (0603) Murata GRM1885C1H220J
C77	1	4.7 μ F \pm 10%, 6.3V X5R ceramic capacitor (0603) Murata GRM188R60J475K
DGND, GND (x3)	4	Black test points
DVDD, EXT_VDD, VLED	3	Red test points
EXIRLED1, EXIRLED2, EXT_INTB, EXT_SCL, EXT_SDA	5	White test points
IRLED1	1	70mA, 1.6V, 860nm IR LED diode (MIDLED) Osram SFH4651
IRLED2	0	Not installed, diode
J1	1	2 x 3 right-angle female header
J2	0	Not installed, 24-pin (2 x 12) header
J3,	1	USB type-B right-angle PC-mount receptacle
J4	1	2 x 3 right-angle male header
JSPI	0	Not installed, 6-pin header
JTAG1	1	6-pin header
JTAG2	1	Dual-row 10-pin (2 x 5) header
JU1–JU4	0	Not installed, 2-pin headers
JU5	0	Not installed, 3-pin header
JU6, JU7, JU8, JU11	4	2-pin headers
JU10, JU12–JU16	6	3-pin headers
JU17	1	4-pin header
L1,	1	Ferrite bead (0603) TDK MMZ1608R301A
LED1, LED2, LED3	3	Red LEDs (0603)

DESIGNATION	QTY	DESCRIPTION
LD1, LD2	2	Light dams Maxim EPCB44000LD+
Q100	1	p-channel FET (SOT223)
R1, R3, R4, R19, R21–R24	8	4.7k Ω \pm 5% resistors (0603)
R2, R16, R17, R18	4	100 Ω \pm 5% resistors (0603)
R5	1	390 Ω \pm 5% resistor (0603)
R6, R7, R8, R27, R36, R57, R58–R61	10	10k Ω \pm 5% resistors (0603)
R9, R10, R11	3	200 Ω \pm 5% resistors (0603)
R12, R14, R25, R29	4	10 Ω \pm 5% resistors (0603)
R13	1	150 Ω \pm 5% resistor (0603)
R15	1	56 Ω \pm 5% resistor (0603)
R20, R28	2	680 Ω \pm 5% resistors (0603)
R26, R100	2	1k Ω \pm 5% resistors (0603)
R30	1	18.7k Ω \pm 1% resistor (0603)
R31, R43, R44, R46	4	10k Ω \pm 1% resistors (0603)
R32, R33	2	27 Ω \pm 5% resistors (0603)
R34	1	1.5k Ω \pm 5% resistor (0603)
R35	1	2.2k Ω \pm 5% resistor (0603)
R37–R41	0	Not installed, resistors (0603)
R42, R45, R62	3	100k Ω \pm 5% resistors (0603)
R47	1	20k Ω \pm 1% resistor (0603)
R48	1	470 Ω \pm 5% resistor (0603)
R55	1	49.9k Ω \pm 1% resistor (0603)
R56	1	40.2k Ω \pm 1% resistor (0603)
S1	1	4-position, half-pitch SMT DIP switch
U1	1	Ambient and infrared proximity sensor (6 OTDFN) Maxim MAX44000GDT+
U2	1	White LED driver (24 TQFN) Maxim MAX8879ETG+
U3	0	Not installed, serial PROM
U4	0	Not installed, SPI flash
U6, U7	2	LDOs (16 TSSOP-EP) Maxim MAX1793EUE50+
U8	1	USB-to-UART converter (32 TQFP)
U9	1	93C46 type 3-wire EEPROM (8 SO)

MAX44000 Evaluation System

Evaluates: MAX44000

Component Lists (continued)

MAX44000 EV Kit (continued)

DESIGNATION	QTY	DESCRIPTION
U10, U15	2	LDOs (6 SOT23) Maxim MAX1983EUT+
U13	1	Spartan 3AN FPGA (144-TQFP)
U14	1	Microcontroller (68 QFN-EP) Maxim MAXQ2000-RAX+
WLED	1	White LED
Y1	1	50MHz oscillator
Y2	1	6MHz crystal Hong Kong X'tals SSL60000N1HK188F0-0

DESIGNATION	QTY	DESCRIPTION
Y3	0	Not installed, crystal
Y4	1	20MHz crystal
—	4	0.250in x 0.625in 4-40 round nylon spacers
—	4	4-40 x 0.375in nylon machine screws
—	1	USB high-speed A-to-B cables, 6ft
—	11	Shunts
—	1	PCB: MAX44000 EVALUATION KIT

MAX44000 Daughter Board

DESIGNATION	QTY	DESCRIPTION
C1	1	1 μ F \pm 10%, 10V X7R ceramic capacitor (0603) Murata GRM188R71A105K
IRLED1	1	70mA, 1.6V, 860nm IR LED diode (MIDLED) Osram SFH4651

DESIGNATION	QTY	DESCRIPTION
J1	1	2 x 3 right-angle female header
U1	1	Ambient and infrared proximity sensor (6 OTDFN) Maxim MAX44000GDT+
PCB	1	PCB: MAX44000 DAUGHTER BOARD+

Component Suppliers

SUPPLIER	PHONE	WEBSITE
Hong Kong X'tals Ltd.	852-35112388	www.hongkongcrystal.com
Murata Electronics North America, Inc.	770-436-1300	www.murata-northamerica.com
Taiyo Yuden	800-348-2496	www.t-yuden.com
TDK Corp.	847-803-6100	www.component.tdk.com

Note: Indicate that you are using the MAX44000 when contacting these component suppliers.

MAX44000 EV System Files

FILE	DESCRIPTION
INSTALL.EXE	Installs the EV system files on your computer
MAX44000.EXE	Application program
CDM20600.EXE	Installs the USB device driver
UNINSTALL.EXE	Uninstalls the EV kit software
USB_Driver_Help_200.PDF	USB driver installation help file

MAX44000 Evaluation System

Evaluates: MAX44000

Quick Start

Required Equipment

- MAX44000 EV kit (USB cable included)
- Windows XP, Windows Vista, or Windows 7 PC with a spare USB port

Note: In the following sections, software-related items are identified by bolding. Text in **bold** refers to items directly from the EV system software. Text in **bold and underline** refers to items from the Windows operating system.

Procedure

The EV kit is fully assembled and tested. Follow the steps below to verify board operation:

- 1) Visit www.maxim-ic.com/evkitsoftware to download the latest version of the EV kit software, 44000Rxx.ZIP. Save the EV kit software to a temporary folder and uncompress the ZIP file.
- 2) Install the EV kit software and USB driver on your computer by running the INSTALL.EXE program inside the temporary folder. The program files are copied to your PC and icons are created in the Windows **Start | Programs** menu. During software installation, some versions of Windows may show a warning message indicating that this software is from an unknown publisher. This is not an error condition and it is safe to proceed with installation. Administrator privileges are required to install the USB device driver on Windows.
- 3) Verify that all jumpers (JU6, JU7, JU8, and JU10–JU17) are in their default positions, as shown in Table 1.
- 4) Connect the USB cable from the PC to the EV kit board. A Windows message appears when connecting the EV kit board to the PC for the first time. Each version of Windows has a slightly different message. If you see a Windows message stating **ready to use**, then proceed to the next step. Otherwise, open the USB_Driver_Help_200.PDF document in the Windows **Start | Programs** menu to verify that the USB driver was installed successfully.
- 5) Start the EV kit software by opening its icon in the **Start | Programs** menu. The EV kit software main window appears, as shown in Figure 1.
- 6) On the **Proximity Sensor Configuration** tab sheet (Figure 2), in the **Transmit Configuration** group box, use the **LED Drive Current (DRV[3:0])** track bar to set the IR LED current to 10mA. Press the adjacent **Set** button.
- 7) Select **ALS and Prox interleaved** from the **Operation Mode** drop-down list.

- 8) On the **Data Conversion** tab sheet (Figure 1), press the **Convert Start** button in the **Continuous Conversion** group box to view the ambient and proximity ADC data on the graphs.

Detailed Description of Software

The MAX44000 EV kit software (Figure 1) has all the functions to configure the MAX44000 and receive the ADC data from the device. The software contains an **I2C Interface** group box, a **Status** group box, and four tab sheets to configure the device and receive the ambient and proximity data from the device.

I2C Interface

In the **I2C Interface** group box, enter the register address in the **Reg Address** edit box and press the **Read** button to read the register. The returned value is shown in the **Data** edit box. To write a data into a register, enter the register address in the **Reg Address** edit box, enter the data into the **Data** edit box, and press the **Write** button.

Operating Mode

Use the **Operating Mode** drop-down list to select one of the six operating modes. The operating modes are: **Shutdown**, **Standard ALS**, **ALS Green channel only**, **ALS Red channel only**, **ALS and Prox interleaved**, and **Prox only**.

Data Conversion Tab

The **Single Conversion** group box on the **Data Conversion** tab sheet displays the **Ambient** and **Proximity** ADC values for a single sample. Press the **Convert** button to update the values in the **Ambient** and **Proximity** group boxes. Check the **Auto Convert** checkbox to automatically and repeatedly do the ADC conversion and update the values in the **Ambient** and **Proximity** group boxes. Check the **Save to File** checkbox to save the received data to a file.

Press the **Convert Start** button in the **Continuous Conversion** group box to continuously read the ambient and proximity ADC data from the device and plot the data on the **Ambient Sensor** and **Proximity Sensor** graphs. The rate that the controller reads the data from the device is selected from the **Displaying Rate** drop-down list. The last ambient and proximity samples are displayed in the **Last ALS/PROX Reading** group box in the **Status** group box. Check the **Save to File** checkbox to save the received data to a file.

The white LED (WLED) on the EV kit simulates the back-light of a cell phone. The software adjusts the brightness of the WLED according to the ambient measurement.

MAX44000 Evaluation System

Evaluates: MAX44000

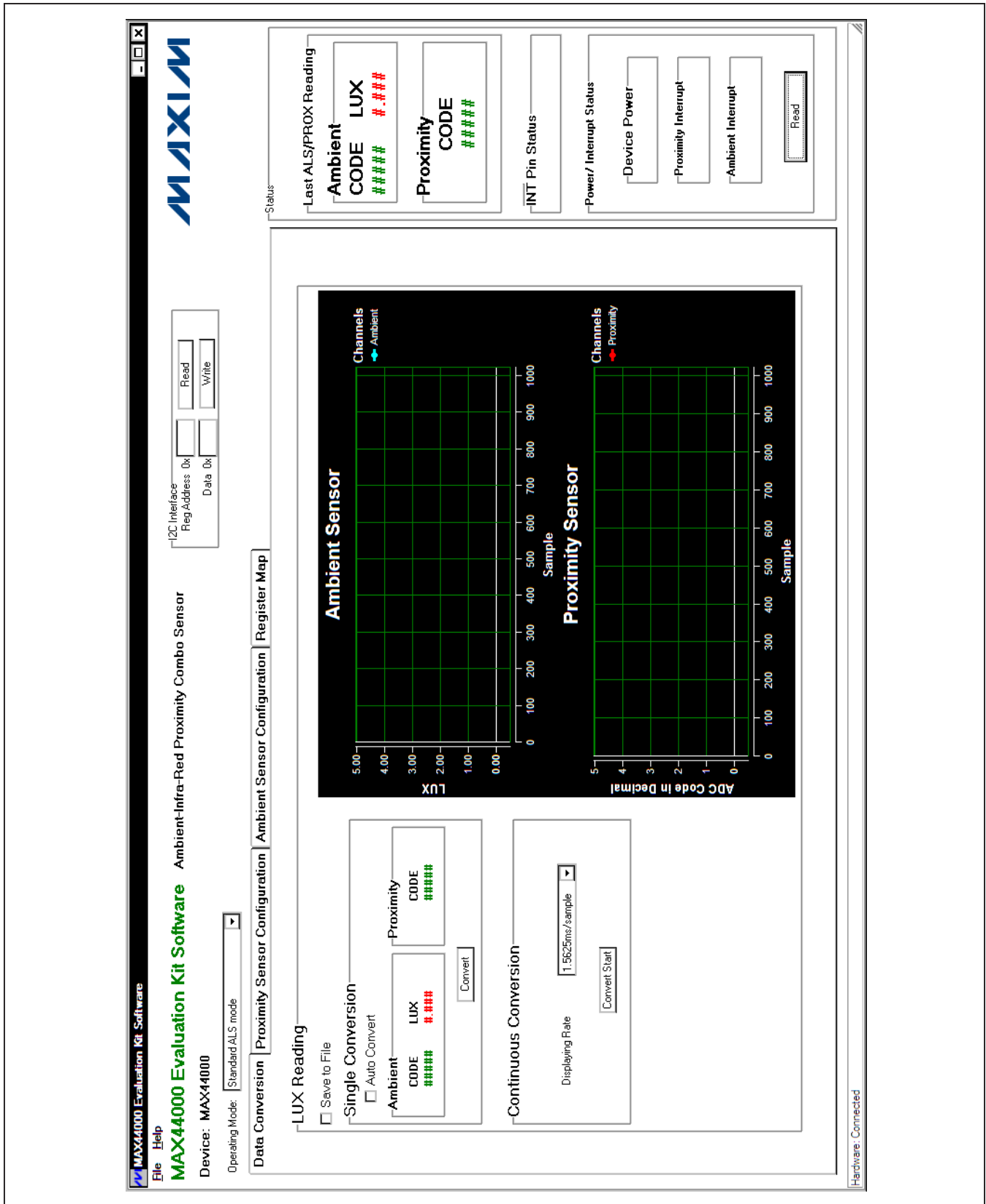

Figure 1. MAX44000 EV Kit Software Main Window

MAX44000 Evaluation System

Evaluates: MAX44000

Proximity Sensor Configuration Tab

The **Proximity Sensor Configuration** tab sheet (Figure 2) has all the functions to configure the proximity sensor of the device.

In the **Transmit Configuration** group box, use the **LED Drive Current (DRV[3:0])** track bar to select the desired IRLED drive current. The **IR Proximity LED current** is shown on the right of the track bar. Press the **Set** button to set the DRV register.

The **Proximity Threshold** group box can be used to control the proximity interrupt function. Use the **Receiver Threshold (PRXTHR[7:0])** track bar to select the proximity threshold level and press the adjacent **Set** button to set the PRXTHR register. After the **Proximity Interrupt Enable** checkbox is checked, if the **Above the Receiver Threshold** radio button is selected in the **ABOVE / BELOW Proximity Receiver Select (ABOVE)** group box, and the proximity measurement is greater than the value stored in the PRXTHR register, the interrupt event is recorded. Similarly, if the **Below the Receiver Threshold** radio button is selected, and the proximity measurement is less than the value stored in the PRXTHR register, the interrupt event is recorded. Use the **PRXPST[1:0]** drop-down list in the **Timer Threshold** group box to set the persist value that controls how readily the proximity interrupt logic reacts to a detected event.

Ambient Sensor Configuration Tab

The **Ambient Sensor Configuration** tab sheet (Figure 3) has all the functions to configure the ambient sensor of the device.

In the **Receive Configuration** group box, use the **ALSTIM[1:0]** drop-down list to set the integration time and resolution for the ALS ADC. The **ALSPGA[1:0]** drop-down list sets the gain of the ambient light sensing measurement.

Use the **LUX Thresholds** group box to set the upper and lower lux threshold. After the **Ambient Interrupt Enable** checkbox is checked, if the ambient measurement is higher than the upper threshold or lower than the lower threshold, the interrupt event is recorded. The interrupt bit is reset only after reading the interrupt status register.

In the **Upper Threshold** group box, use the **UPTHR[13:0]** track bar to select the desired upper lux threshold. Press the adjacent **Set** button to set the UPTHR register. Similarly use the **LOTHR[13:0]** track bar in the **Lower Threshold** group box to select the desired lower lux threshold and press the adjacent **Set** button to set the LOTHR register.

Use the **ALSPST[1:0]** drop-down list in the **Timer Threshold** group box to set the persist value that controls how readily the ambient interrupt logic reacts to a detected event.

The **Gain Control** group box is used to modify the gain of the green channel and the IR channel. Use the **TRIM_GAIN_GREEN[6:0]** track bar to select the gain trim for the green channel. Use the **TRIM_GAIN_IR[8:0]** track bar to select the gain trim for the IR channel. Press the **Set** button to set the TRIM_GAIN_GREEN and TRIM_GAIN_IR registers. Check the **TRIM Enable** checkbox to force the part to use the trim value written in the trim gain registers.

Status

In the **Status** group box, the **Last ALS/PROX Reading** group box displays the last set of ambient and proximity ADC data from the graphs on the **Data Conversion** tab sheet (Figure 1).

Press the **Read** button to read the status of the interrupt pin (INT). If the interrupt signal is asserted, the status register (0x00) is read and displayed in the **Power/Interrupt Status** group box.

Register Map

The **Register Map** tab sheet (Figure 4) contains a register map of the device. The tab is organized from left to right with register names, bit names, register addresses, edit boxes, **Read** buttons, and **Write** buttons. The bit names are used to display the current state of each bit (bold text = 1). In addition, a register's bits can be individually toggled by single-clicking on the bit's name. The edit boxes are used to display a register's state and are updated after a bit click or **Read** button press. The user can also change the value of the register by entering a value in the edit box and pressing the adjacent **Write** button.

MAX44000 Evaluation System

Evaluates: MAX44000

The screenshot displays the 'MAX44000 Evaluation Kit Software' interface. The main window title is 'MAX44000 Evaluation Kit Software Ambient-Infra-Red Proximity Combo Sensor'. The device is identified as 'MAX44000' and is currently in 'Standard ALS mode'. The interface is divided into several functional areas:

- Navigation and Controls:** A menu bar with 'File' and 'Help'. Below it, a toolbar contains 'Data Conversion', 'Proximity Sensor Configuration', 'Ambient Sensor Configuration', and 'Register Map'. On the right, there are 'I2C Interface' fields for 'Reg Address 0x' and 'Data 0x', along with 'Read' and 'Write' buttons.
- Configuration Panels:**
 - Configuration:** Includes a checkbox for 'Proximity Interrupt Enable'. The 'Transmit Configuration' section shows 'LED Drive Current (DRV[3:0])' set to 0 mA.
 - Proximity Threshold:** Features a slider for 'Receiver Threshold (PRXTHR[7:0])' set to 253, with a 'Set' button. Below it, radio buttons allow selection for 'ABOVE / BELOW / Proximity Receiver Select (ABOVE)', with 'Above the Receiver Threshold' selected.
 - Timer Threshold:** Includes a dropdown for 'Number of consecutive measurements that trip an interrupt' set to 1, and a 'PRXPST[1:0]' field.
- Status Panel:** Located at the bottom, it displays:
 - 'Last ALS/PROX Reading' with 'Ambient CODE LUX' and 'Proximity CODE' fields, each showing '#####'.
 - 'INT Pin Status' field.
 - 'Power/ Interrupt Status' section with 'Device Power', 'Proximity Interrupt', and 'Ambient Interrupt' fields, each with a 'Read' button.
- Footer:** A status bar at the bottom right indicates 'Hardware: Connected'.

Figure 2. Proximity Sensor Configuration Tab

MAX44000 Evaluation System

Evaluates: MAX44000

The screenshot displays the 'Ambient Sensor Configuration' tab of the MAX44000 Evaluation System software. The interface is organized into several functional areas:

- Header:** Includes the MAXIM logo, 'MAX44000 Evaluation Kit Software', and 'Ambient-Infra-Red Proximity Combo Sensor'.
- Navigation:** A menu bar with 'File' and 'Help', and a breadcrumb trail: 'Data Conversion' > 'Proximity Sensor Configuration' > 'Ambient Sensor Configuration' > 'Register Map'.
- Device Information:** Shows 'Device: MAX44000' and 'Operating Mode: Standard ALS mode'.
- I2C Interface:** Fields for 'Reg Address 0x' and 'Data 0x', with 'Read' and 'Write' buttons.
- Configuration Panels:**
 - Receive Configuration:** Includes 'Ambient Interrupt Enable' (checkbox), 'Integration Timer' (100ms, 14-bit), and 'Gain' (Counts/lux = 32, FS = 511 Lux).
 - LUX Thresholds:** Features 'Upper Threshold' (UPTHR[13:0]) and 'Lower Threshold' (LOTHR[13:0]), both with sliders and 'Set' buttons.
 - Timer Threshold:** Includes 'Number of consecutive measurements that trip an interrupt' (set to 1) and 'ALSPT1[1:0]'.
 - Gain Control:** Includes 'TRIM Enable' (checkbox) and sliders for 'TRIM_GAIN_GREEN[6:0]' (set to 105) and 'TRIM_GAIN_IR[8:0]' (set to 163).
- Status Panel:** Located at the bottom, it shows 'Last ALS/PROX Reading' with 'Ambient CODE LUX' (###) and 'Proximity CODE' (###). It also includes 'INT Pin Status', 'Power/Interrupt Status' (Device Power, Proximity Interrupt, Ambient Interrupt), and a 'Read' button.
- Footer:** A status bar at the bottom right indicates 'Hardware: Connected'.

Figure 3. Ambient Sensor Configuration Tab

MAX44000 Evaluation System

Evaluates: MAX44000



File Help
MAX44000 Evaluation Kit Software
Ambient-Infra-Red Proximity Combo Sensor
Device: MAX44000

Operating Mode: Standard ALS mode

12C Interface
Reg Address: 0x
Data: 0x

Read Write



Data Conversion | **Proximity Sensor Configuration** | **Ambient Sensor Configuration** | **Register Map**

Read All

Register	B7	B6	B5	B4	B3	B2	B1	B0	Reg Addr	Data
Interrupt Status	N/A	N/A	N/A	N/A	N/A	PWRDN	PRXINTS	ALSINTS	0x00	0x00
Main Config	N/A	N/A	TRIMB	MODE2	MODE1	MODE0	PRXINTE	ALSINTE	0x01	0x00
Receive Config	N/A	N/A	PRXPGA1	PRXPGA0	ALSTIM1	ALSTIM0	ALSPGA1	ALSPGA0	0x02	0x00
ALS ADC HB	N/A	N/A	N/A	N/A	DRV3	DRV2	DRV1	DRV0	0x03	0x00
ALS ADC LB	N/A	ALSDATA6	ALSDATA5	ALSDATA4	ALSDATA3	ALSDATA2	ALSDATA1	ALSDATA0	0x04	0x00
ALS Upper Thres HB	N/A	N/A	UPTHR13	UPTHR12	UPTHR11	UPTHR10	UPTHR9	UPTHR8	0x05	0x00
ALS Upper Thres LB	N/A	N/A	UPTHR5	UPTHR4	UPTHR3	UPTHR2	UPTHR1	UPTHR0	0x06	0x00
ALS Lower Thres HB	N/A	N/A	LOTHR13	LOTHR12	LOTHR11	LOTHR10	LOTHR9	LOTHR8	0x07	0x00
ALS Lower Thres LB	N/A	N/A	LOTHR5	LOTHR4	LOTHR3	LOTHR2	LOTHR1	LOTHR0	0x08	0x00
Threshold Persist Timer	N/A	N/A	N/A	N/A	PRXPST1	PRXPST0	ALSPST1	ALSPST0	0x09	0x00
PROX Thres HB	N/A	ABOVE	PRXTHR13	PRXTHR12	PRXTHR11	PRXTHR10	PRXTHR9	PRXTHR8	0x0A	0x00
PROX Thres LB	N/A	N/A	PRXTHR5	PRXTHR4	PRXTHR3	PRXTHR2	PRXTHR1	PRXTHR0	0x0B	0x00
N/A	N/A	N/A	N/A	N/A	N/A	N/A	N/A	N/A	0x0C	0x00
N/A	N/A	N/A	N/A	N/A	N/A	N/A	N/A	N/A	0x0D	0x00
N/A	N/A	N/A	N/A	N/A	N/A	N/A	N/A	N/A	0x0E	0x00
Gain Trim of Green Ch	TRIM_GREEN6	TRIM_GREEN5	TRIM_GREEN4	TRIM_GREEN3	TRIM_GREEN2	TRIM_GREEN1	TRIM_GREEN0	TRIM_JR0	0x0F	0x00
Gain Trim of Infrared Ch	TRIM_JR8	TRIM_JR7	TRIM_JR6	TRIM_JR5	TRIM_JR4	TRIM_JR3	TRIM_JR2	TRIM_JR1	0x10	0x00
N/A	N/A	N/A	N/A	N/A	N/A	N/A	N/A	N/A	0x11	0x00
N/A	N/A	N/A	N/A	N/A	N/A	N/A	N/A	N/A	0x12	0x00
N/A	N/A	N/A	N/A	N/A	N/A	N/A	N/A	N/A	0x13	0x00
N/A	N/A	N/A	N/A	N/A	N/A	N/A	N/A	N/A	0x14	0x00
PROX ADC HB	N/A	N/A	PRXDATA13	PRXDATA12	PRXDATA11	PRXDATA10	PRXDATA9	PRXDATA8	0x15	0x00
PROX ADC LB	PRXDATA7	PRXDATA6	PRXDATA5	PRXDATA4	PRXDATA3	PRXDATA2	PRXDATA1	PRXDATA0	0x16	0x00
N/A	N/A	N/A	N/A	N/A	N/A	N/A	N/A	N/A	0x17	0x00
N/A	N/A	N/A	N/A	N/A	N/A	N/A	N/A	N/A	0x18	0x00
N/A	N/A	N/A	N/A	N/A	N/A	N/A	N/A	N/A	0x19	0x00
N/A	N/A	N/A	N/A	N/A	N/A	N/A	N/A	N/A	0x1A	0x00
N/A	N/A	N/A	N/A	N/A	N/A	N/A	N/A	N/A	0x1B	0x00
N/A	N/A	N/A	N/A	N/A	N/A	N/A	N/A	N/A	0x1C	0x00
N/A	N/A	N/A	N/A	N/A	N/A	N/A	N/A	N/A	0x1D	0x00

Read Write

Status

~Last ALS/PROX Reading

Ambient
CODE LUX

#####

~Proximity
CODE
#####

~INT Pin Status

~Power/ Interrupt Status

Device Power

Proximity Interrupt

Ambient Interrupt

Hardware: Connected

Figure 4. Register Map Tab

MAX44000 Evaluation System

Evaluates: MAX44000

Detailed Description of Hardware

The MAX44000 EV system includes one MAX44000 EV kit and one MAX44000 daughter board. The EV kit is a fully assembled and tested PCB that evaluates the device ambient light and proximity sensor. The EV kit comes installed with a MAX44000GDT+ in a 6-pin OTDFN package with an exposed pad.

The daughter board is an external device-under-test module that also comes with a MAX44000GDT+ installed. The daughter board can be connected to and controlled by the EV kit. The user can also evaluate the device by connecting the user-supplied controller to the daughter board.

IR LED

The on-board IR LED is installed next to the device. A light dam board is placed between the IR LED and the device to block crosstalk.

To use a user-supplied IR LED, install the user-supplied IR LED on the IRLED2 footprint and place a shunt on jumper JU17 in the 1-4 position.

To use an external IR LED, connect the external IR LED between the EXIRLED1 and EXIRLED2 connectors. Then place the shunt on JU17 in the 1-3 position.

Power Supply

By default, the EV kit is USB powered. To use an external power supply, connect a 5V supply to the DVDD and DGND connectors, and place a shunt on jumper JU10 in the 2-3 position. The daughter board is powered by its master board.

User-Supplied I²C Interface

To use the device on the EV kit with a user-supplied I²C interface, install shunts on jumpers JU12–JU16 in the 2-3 position. Connect the SCL, SDA, $\overline{\text{INT}}$, VDD, and VLED signals from the external I²C interface to the EXT_SCL, EXT_SDA, EXT_INTB, EXT_VDD, and VLED connectors on the EV kit, respectively.

MAX44000 Daughter Board

To use the daughter board with the EV kit and the EV kit software, remove the shunts on jumpers JU14, JU15, and JU16 to disconnect the device on the EV kit from the on-board controller. Carefully connect the EV kit and the daughter board by aligning the 6-pin right-angle connector (J1) on the daughter board with the 6-pin right-angle header (J4) on the EV kit, and press them together.

Table 1. Jumper Settings

JUMPER	SHUNT POSITION	DESCRIPTION
JU6	1-2*	The on-board LDO (U6) provides a 3.6V output to the EV kit.
	Open	Disconnects the output of the on-board LDO (U6).
JU7	1-2*	The on-board LDO (U7) provides a 2.5V output to the EV kit.
	Open	Disconnects the output of the on-board LDO (U7).
JU8	1-2*	The on-board LDO (U10) provides a 1.2V output to the EV system.
	Open	Disconnects the output of the on-board LDO (U10).
JU10	1-2*	On-board LDOs powered from the USB port.
	2-3	Connect an external 5V supply to the DVDD connector.
JU11	1-2*	The on-board LDO (U15) provides a 1.8V output to the EV system.
	Open	Disconnects the output of the on-board LDO (U15).
JU12	1-2*	The on-board 2.5V supply connects to the anode of the IR LED.
	2-3	Connect an external supply to the VLED connector.
JU13	1-2*	The on-board 1.8V supply connects to the VDD pin of the device.
	2-3	Connect an external supply to the EXT_VDD connector.
JU14	1-2*	SDA signal on the device connected to the on-board microcontroller.
	2-3	Connect user-supplied SDA signal to the on-board EXT_SDA pad.
JU15	1-2*	SCL signal on the device connected to the on-board microcontroller.
	2-3	Connect user-supplied SCL signal to the on-board EXT_SCL pad.
JU16	1-2*	$\overline{\text{INT}}$ signal on the device connected to the on-board microcontroller.
	2-3	Connect user-supplied $\overline{\text{INT}}$ signal to the on-board EXT_INTB pad.
JU17	1-2*	DRV signal on the device connected to the cathode of the IRLED1.
	1-3	DRV signal on the device connected to the EXIRLED2 connector.
	1-4	DRV signal on the device connected to the cathode of the IRLED2.

*Default position.

MAX44000 Evaluation System

Evaluates: MAX44000

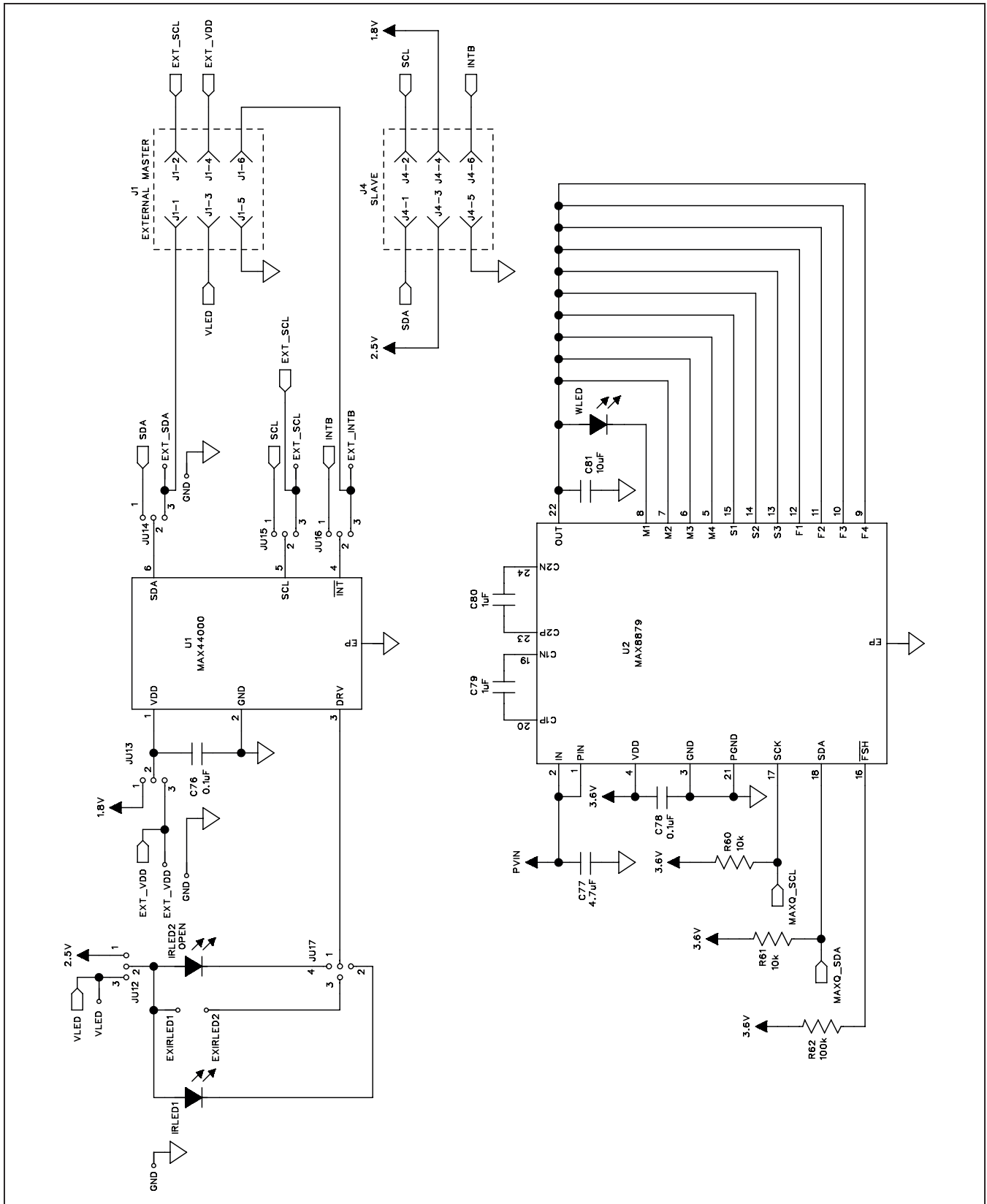

Figure 5a. MAX44000 EV Kit Schematic (Sheet 1 of 5)

MAX44000 Evaluation System

Evaluates: MAX44000

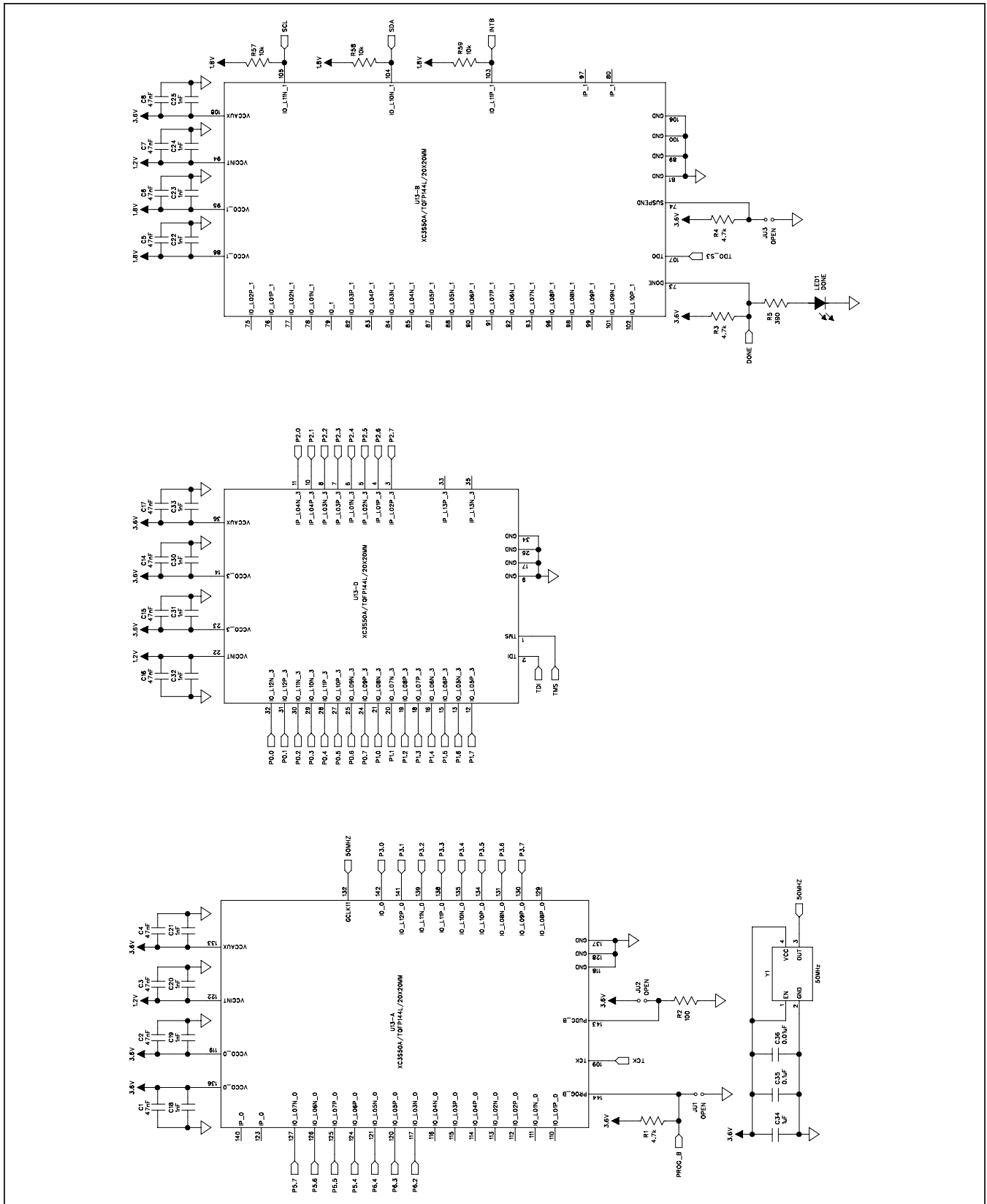

Figure 5b. MAX44000 EV Kit Schematic (Sheet 2 of 4)

MAX44000 Evaluation System

Evaluates: MAX44000

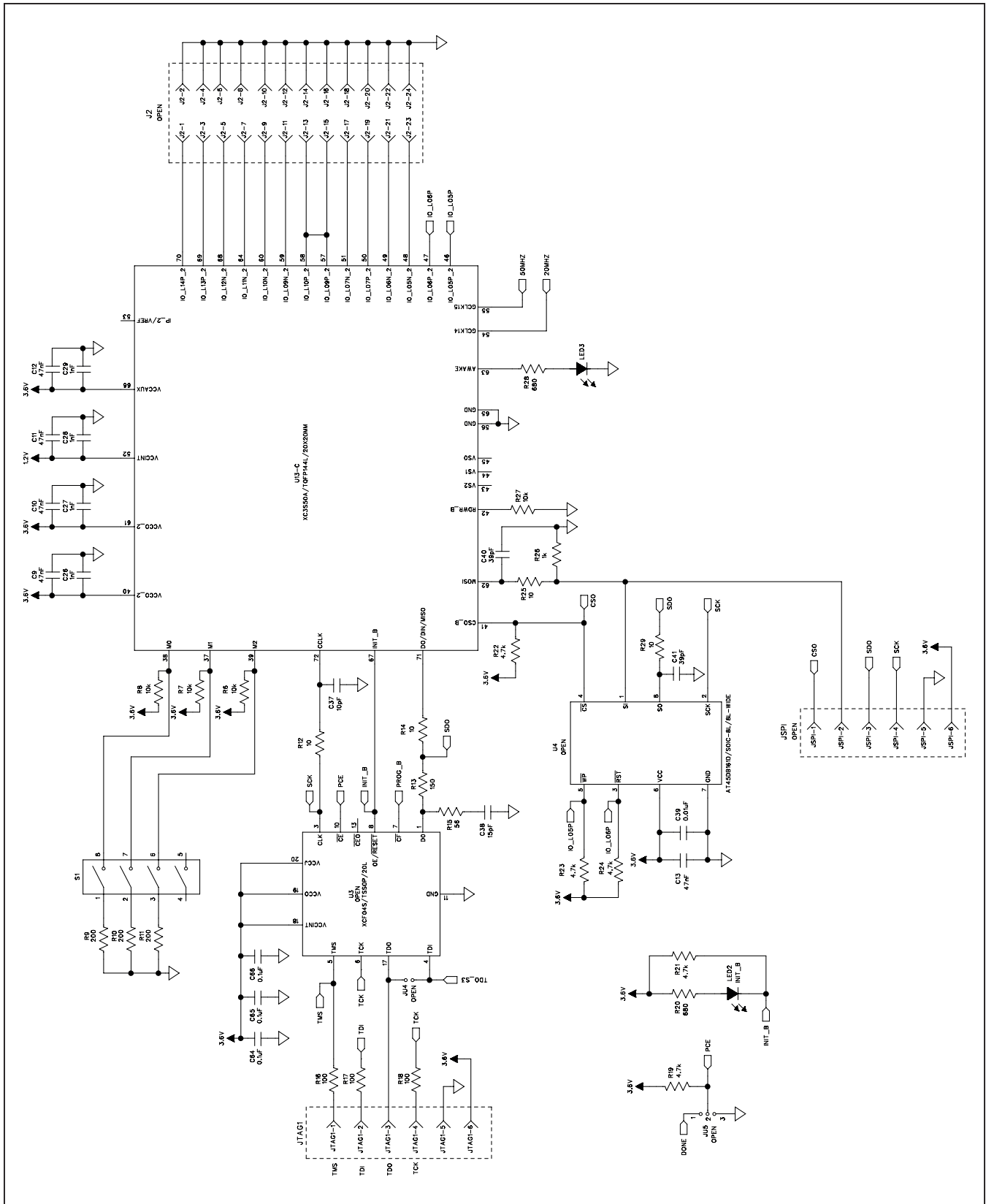

Figure 5c. MAX44000 EV Kit Schematic (Sheet 3 of 4)

MAX44000 Evaluation System

Evaluates: MAX44000

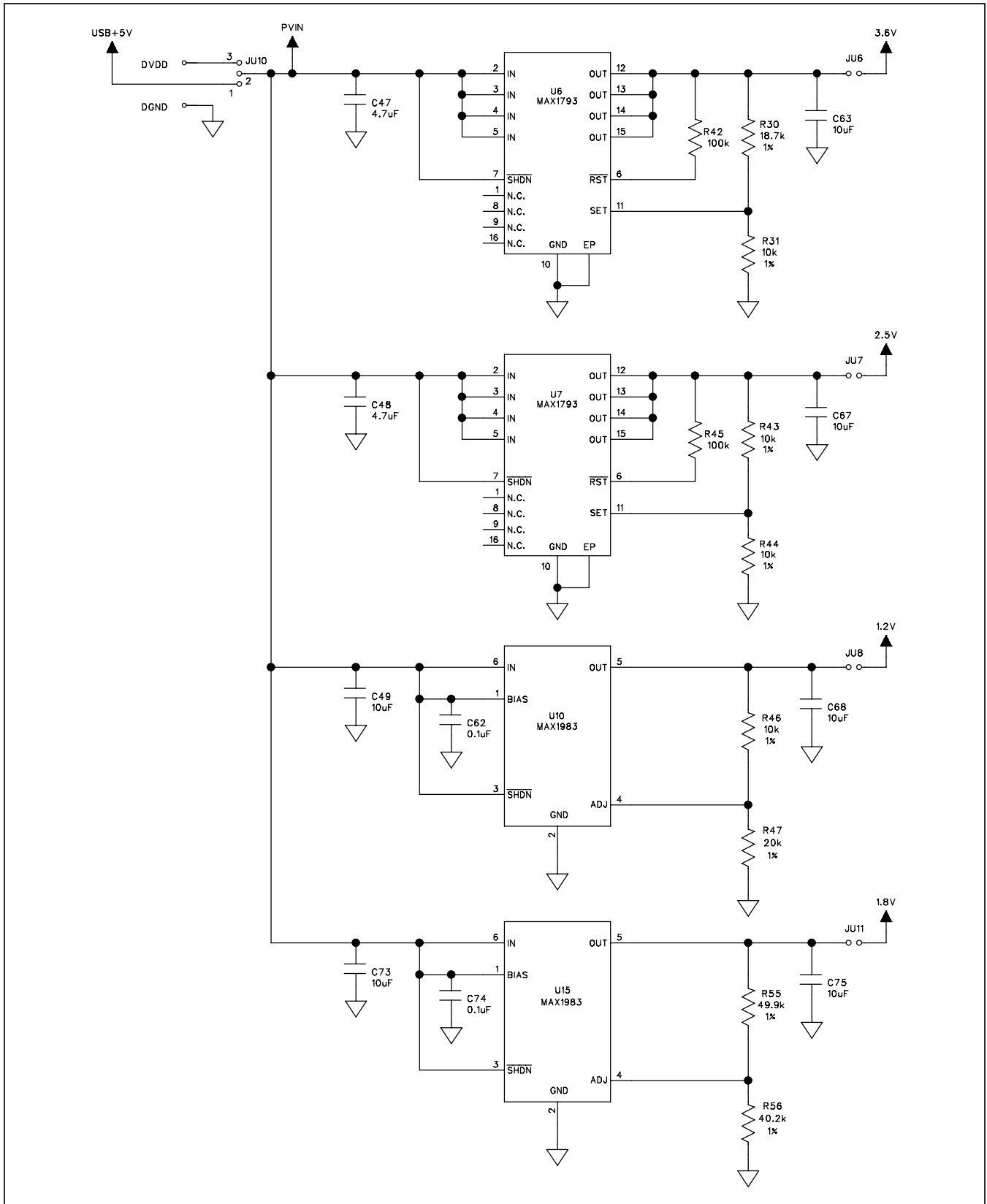

Figure 5d. MAX44000 EV Kit Schematic (Sheet 4 of 5)

MAX44000 Evaluation System

Evaluates: MAX44000

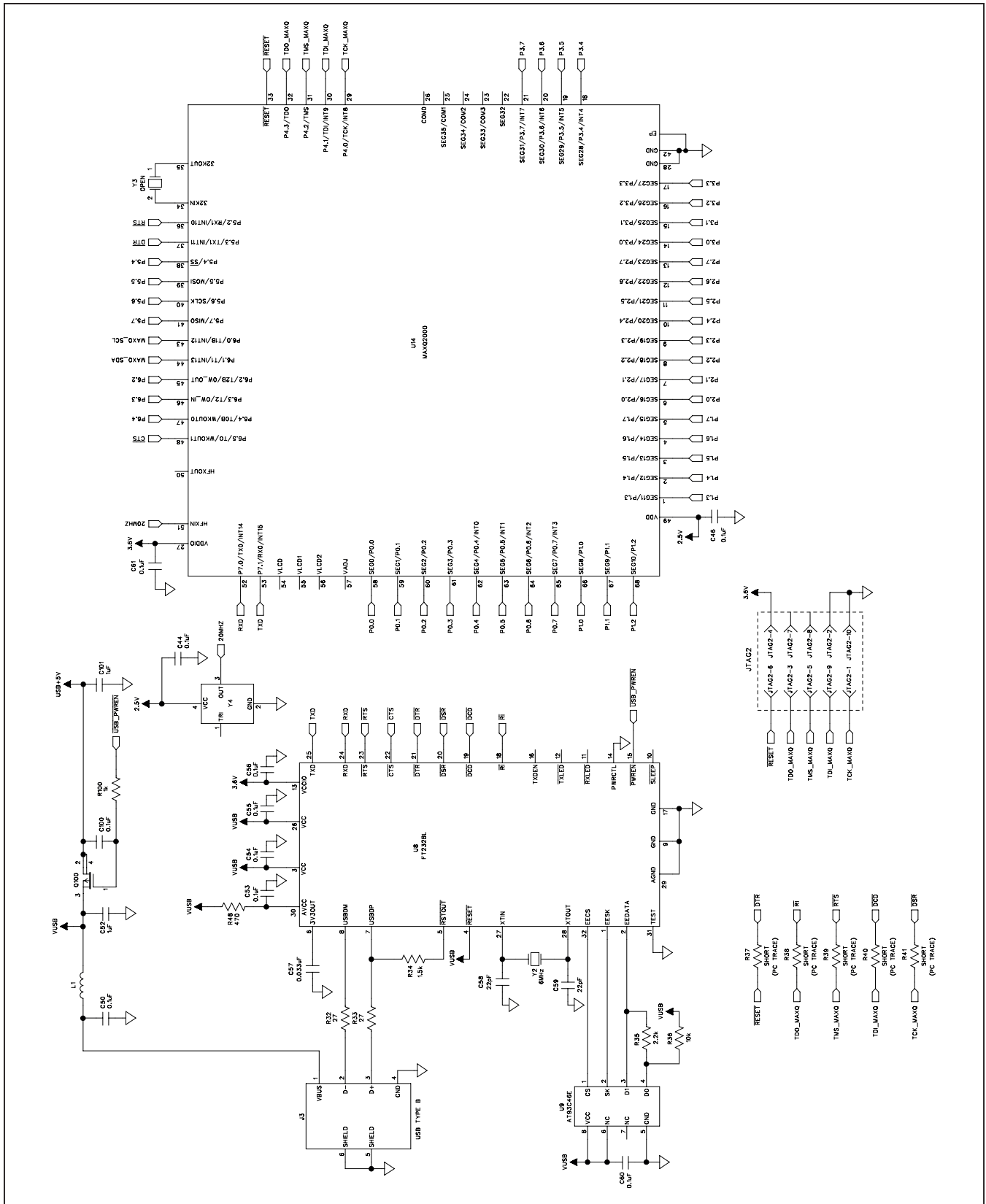

Figure 5e. MAX44000 EV Kit Schematic (Sheet 5 of 5)

MAX44000 Evaluation System

Evaluates: MAX44000

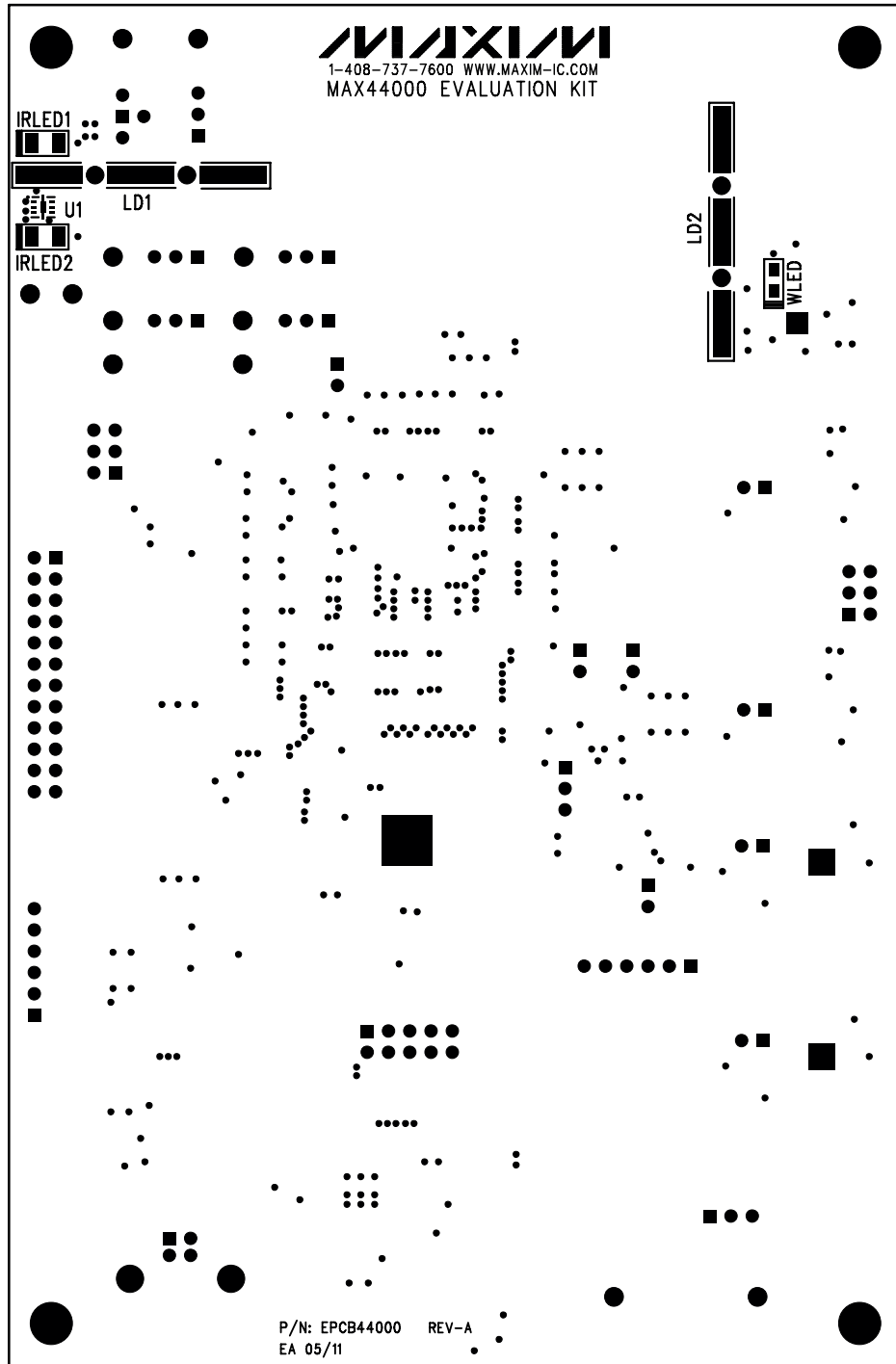

Figure 6. MAX44000 EV Kit Component Placement Guide—Component Side

MAX44000 Evaluation System

Evaluates: MAX44000

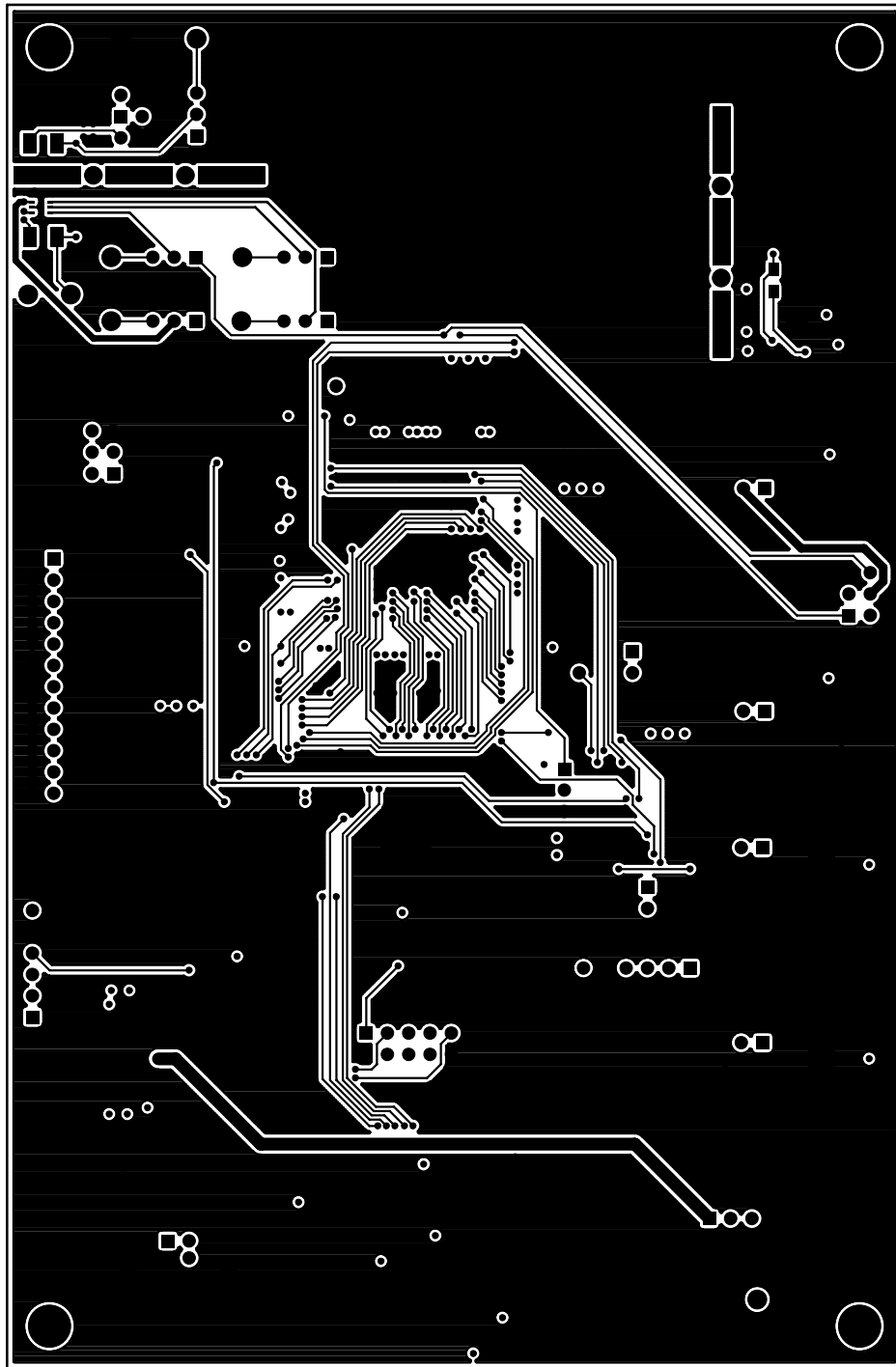

Figure 7. MAX44000 EV Kit PCB Layout—Component Side

MAX44000 Evaluation System

Evaluates: MAX44000

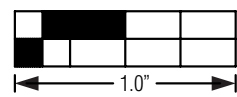
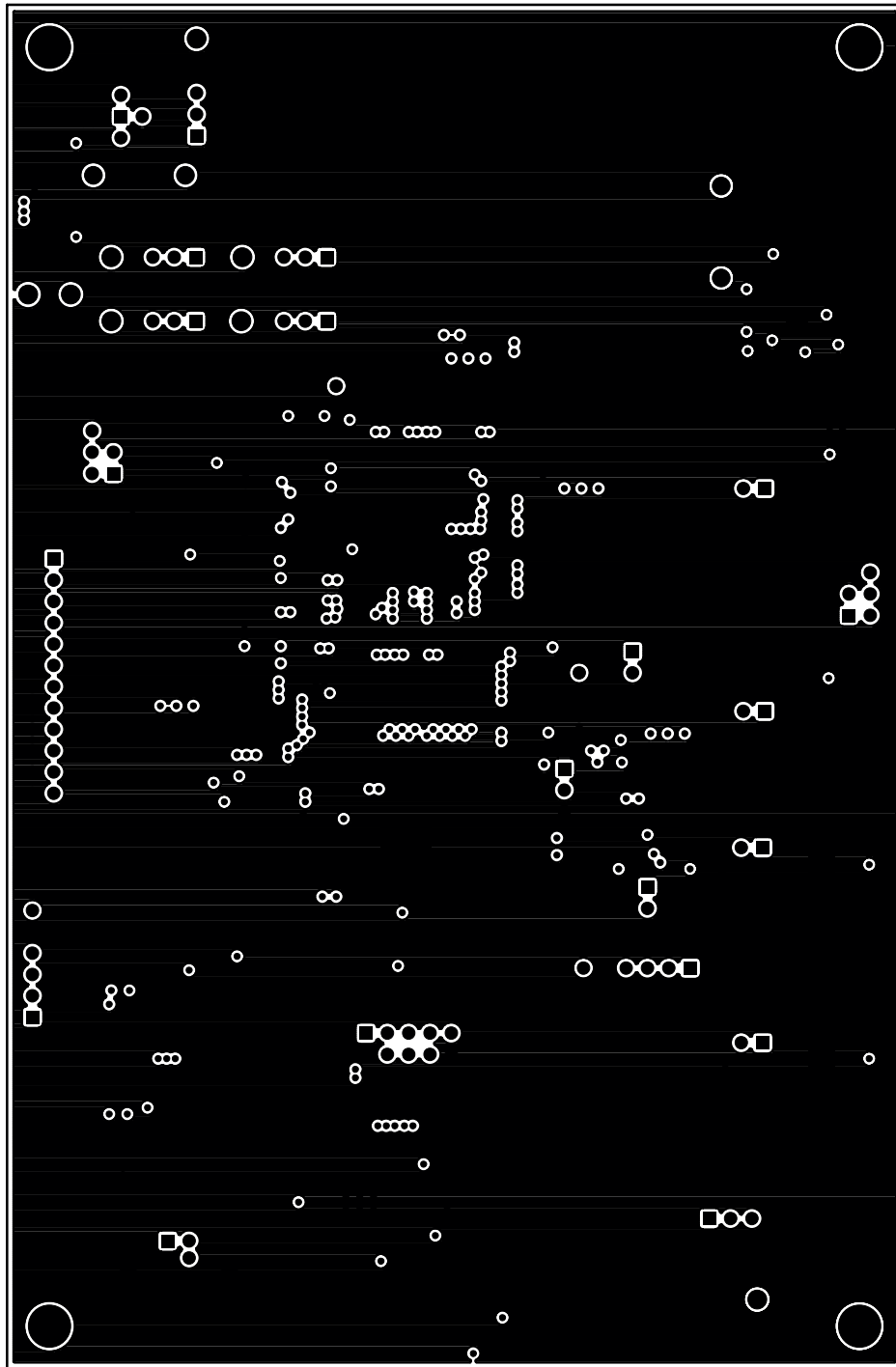

Figure 8. MAX44000 EV Kit PCB Layout—Layer 2

MAX44000 Evaluation System

Evaluates: MAX44000

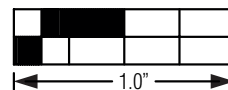
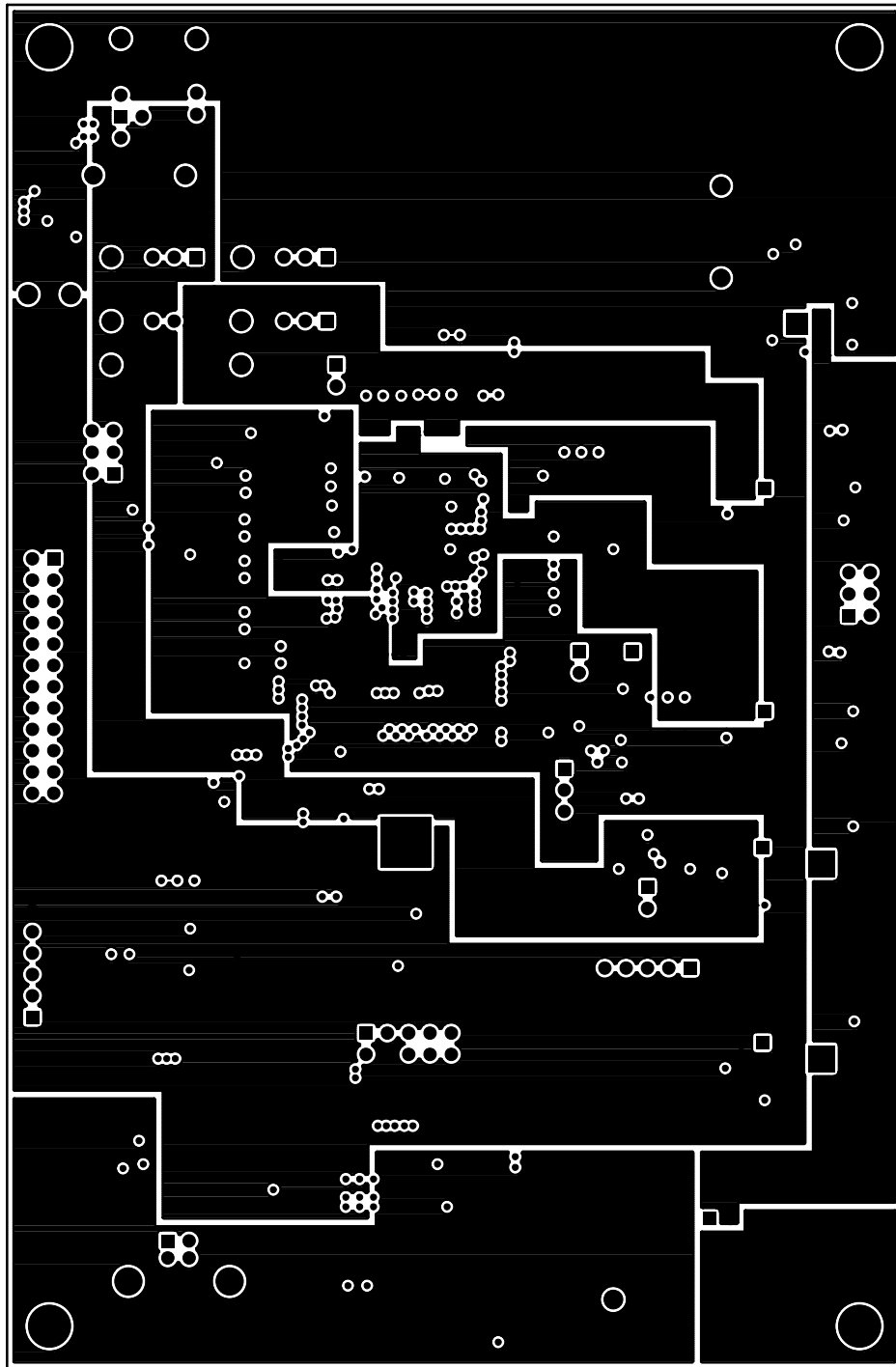

Figure 9. MAX44000 EV Kit PCB Layout—Layer 3

MAX44000 Evaluation System

Evaluates: MAX44000

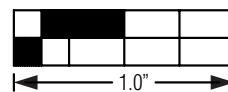
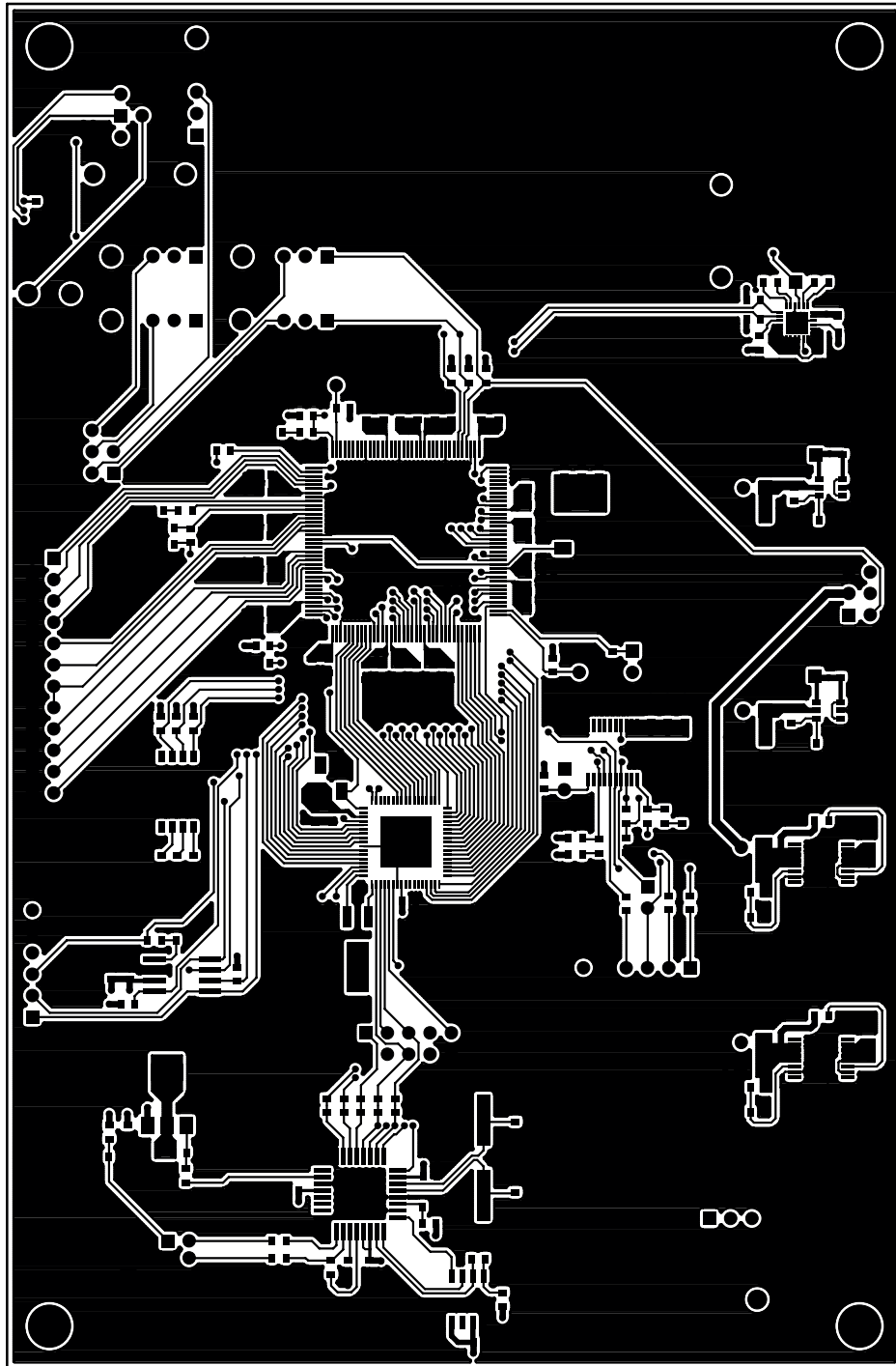

Figure 10. MAX44000 EV Kit PCB Layout—Bottom Side

MAX44000 Evaluation System

Evaluates: MAX44000

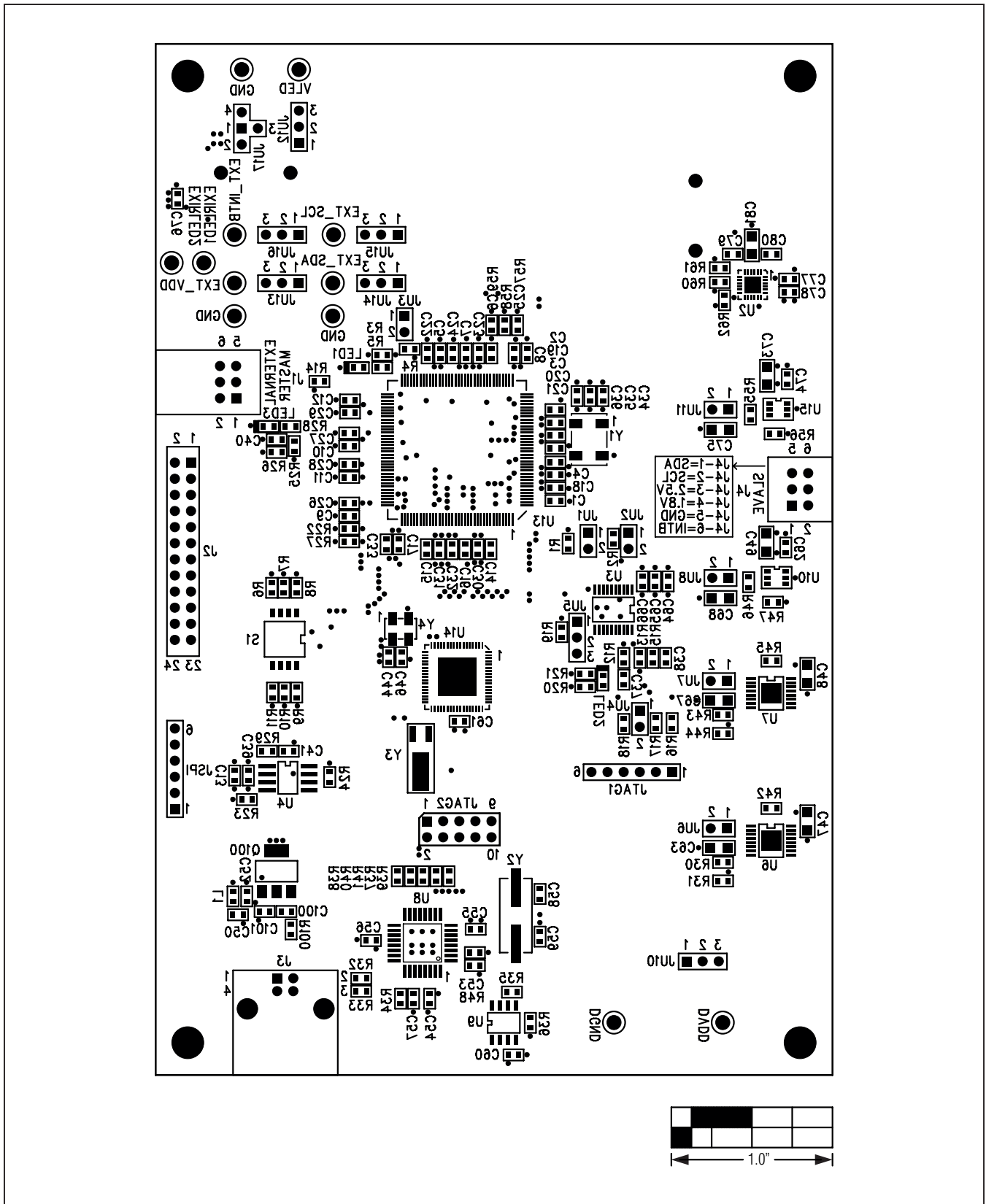

Figure 11. MAX44000 EV Kit Component Placement Guide—Bottom

MAX44000 Evaluation System

Evaluates: MAX44000

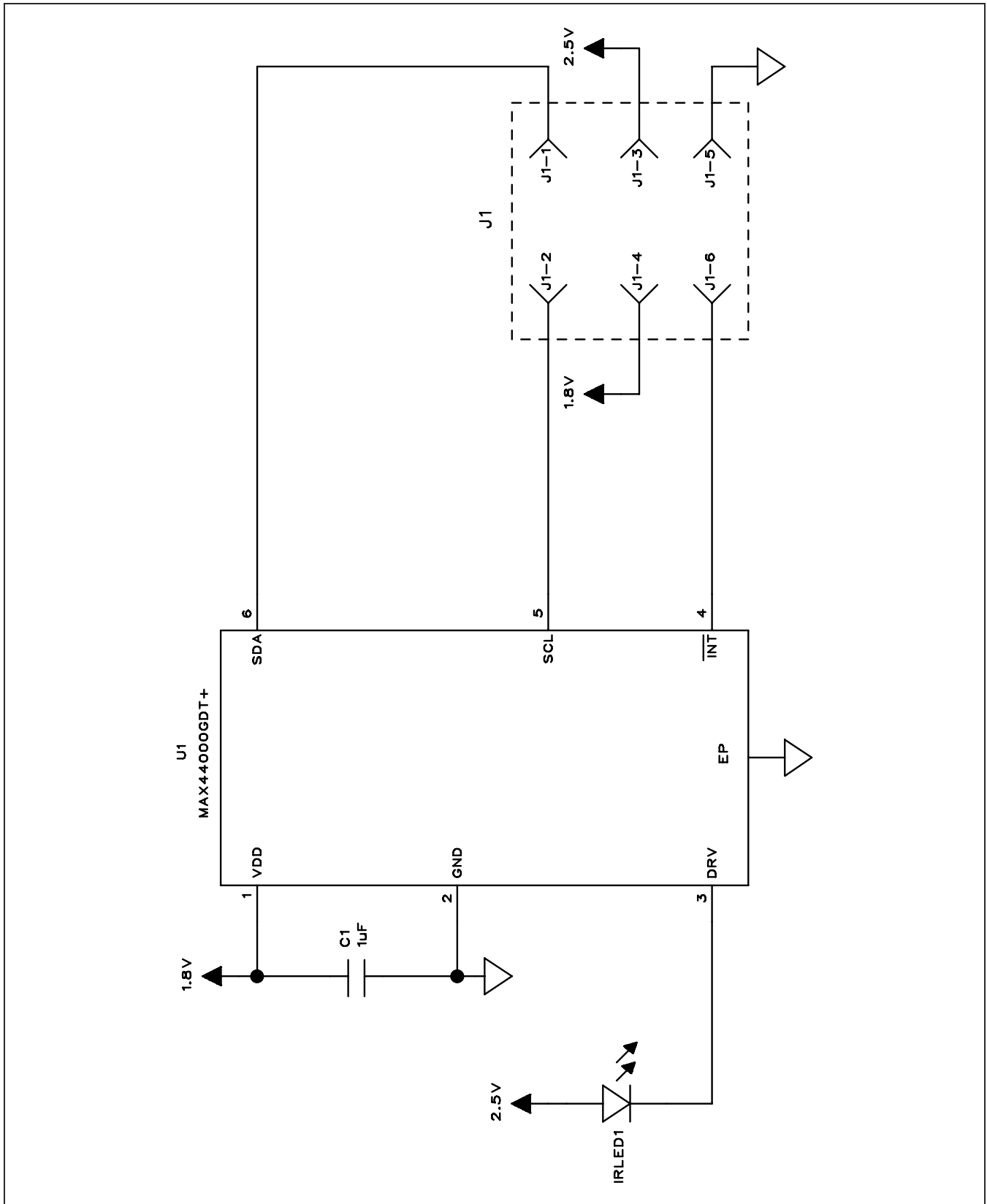

Figure 12. MAX44000 Daughter Board Schematic

MAX44000 Evaluation System

Evaluates: MAX44000

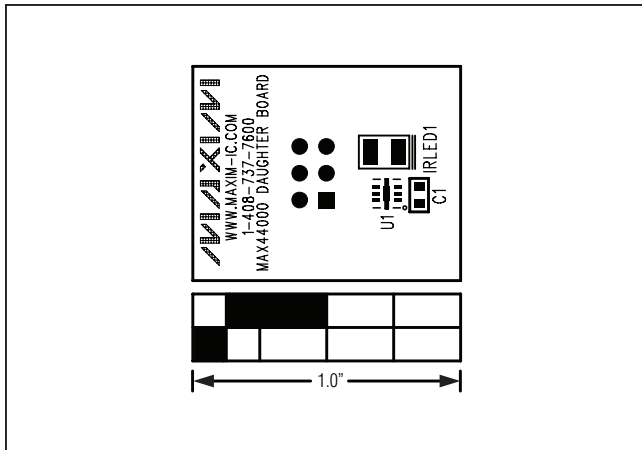

Figure 13. MAX44000 Daughter Board Component Placement Guide—Component Side

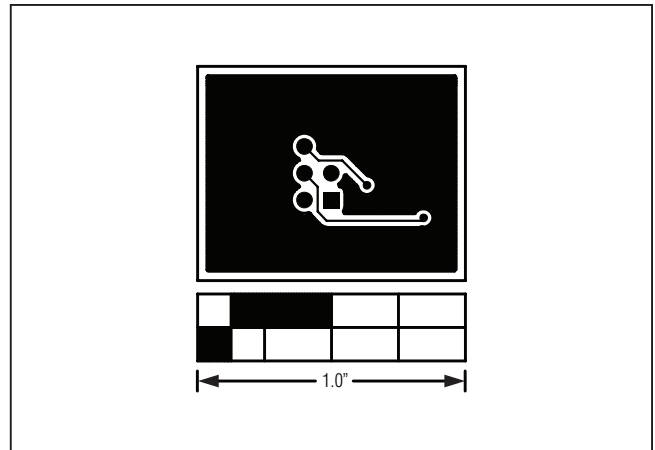

Figure 15. MAX44000 Daughter Board PCB Layout—Bottom

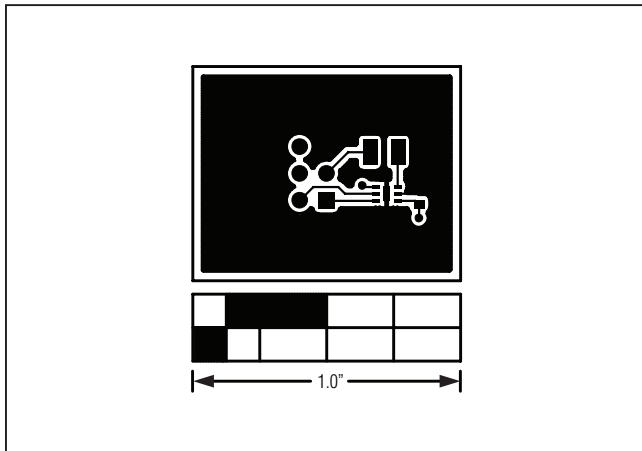

Figure 14. MAX44000 Daughter Board PCB Layout—Top

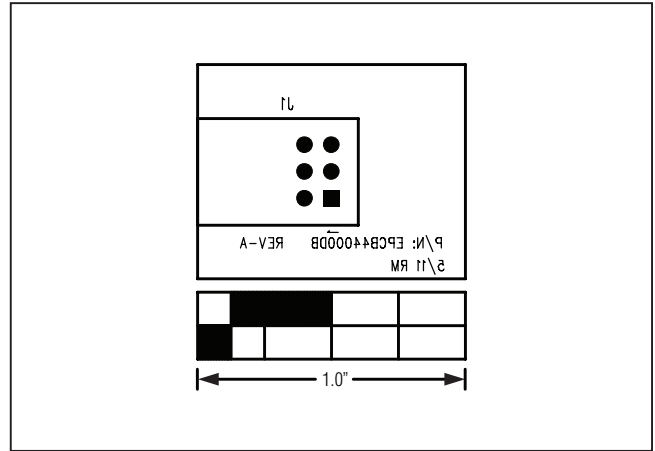

Figure 16. MAX44000 Daughter Board Component Placement Guide—Bottom Side

MAX44000 Evaluation System

Evaluates: MAX44000

Ordering Information

PART	TYPE
MAX44000EVSYS#	EV System

#Denotes RoHS compliant.

MAX44000 Evaluation System

Evaluates: MAX44000

Revision History

REVISION NUMBER	REVISION DATE	DESCRIPTION	PAGES CHANGED
0	11/11	Initial release	—

Maxim cannot assume responsibility for use of any circuitry other than circuitry entirely embodied in a Maxim product. No circuit patent licenses are implied. Maxim reserves the right to change the circuitry and specifications without notice at any time.

Maxim Integrated Products, 120 San Gabriel Drive, Sunnyvale, CA 94086 408-737-7600 _____ 25